



Automation for a Changing World

Delta Vector Control AC Motor Drive



www.deltaww.com

COMTECH Srl Via Polesine 1/4 10020 CAMBIANO (TO) Italy Tel. +39 011/454523



Smarter. Greener. Together.

info@comtech.it www.e-comtech.it



Smarter. Greener. Together.

Who We Are

- A global leader in power and thermal management technology with world-class customers in several industries
- A leading brand of smart automation and energy management solutions for smart factories, industrial processes, data centers, telecom networks, green buildings and more
- Our mission is: “To provide innovative, clean and energy-efficient solutions for a better tomorrow”

About Delta Industrial Automation

Since 1995, the Delta Industrial Automation Business Group (IABG) has focused on automation technology with quality, reliability and precision to realize our promise of “Automation for a Changing World”. Our innovative automation products include AC motor drives, servo drive systems, power quality improvement devices, sensors, programmable logic control, motion control, human machine interfaces, meters, industrial control and monitoring software, and industrial robots.

Delta’s industrial automation solutions find application in a broad range of application machinery, including: metal processing, food, textiles, electronics, plastics, pharmacy, printing, woodworking and machine tools; as well as energy-saving air-conditioning and water supply facilities used in buildings.

Our mission is: “To elevate our living environment through advanced automation technology and value added innovation”. With Delta’s innovative, reliable, energy-saving automation solutions and rapid global service, we help make the world “Smarter. Greener. Together.” with our partners and customers.

Table of Contents

Vector Control Drive 03 **C2000 Series**

Features

Modular Design

Excellent Functions

Model Name

Fan / Pump Vector Control Drive 07 **CP2000 Series**

Features

Standard Models

Model Name

Heavy Duty Vector Control Drive 09 **CH2000 Series**

Features

Standard Models

Model Name

Economy Vector Control Drive 11 **C200 Series**

Features

Excellent Functions

Applications

Model Name

Sensorless Vector Control Compact Drive 13 **VFD-E/EL Series**

Features

Accessories

External Parts

Model Name



C2000 Series



Features

- ▶ Supports both asynchronous and synchronous motors
- ▶ Field oriented vector control
- ▶ Wide power range for different industry needs
- ▶ Built-in 10K steps PLC programming capacity
- ▶ Long service life design
- ▶ Enhanced protections and adaptation to industrial environments
- ▶ Modular design for easy maintenance and many extensions
- ▶ Built-in MODBUS communication and provides for optional communication cards:



CANopen (DS402)

DeviceNet

EtherNet/IP

MODBUS TCP

High-Speed Network

- ▶ Provides optional MODBUS RTU and various fieldbus cards for flexible applications
- ▶ Advanced network functions
- ▶ Built-in MODBUS communication

▶ CANopen (DS402)



▶ EtherNet/IP

▶ MODBUS TCP

Delta provides communication integrator software that offers graphic module settings and a user friendly interface to support all Ethernet products settings and online monitoring.

- Delta software for Ethernet/MODBUS TCP products
- Graphic module settings and a user friendly interface
- Auto search function
- Supports Virtual COM settings



▶ **High-performance Variable-frequency Technology**

- Speed / torque / position control mode
- 4-quadrant torque control and limit
- A drive for induction motors and synchronous motors

▶ **Versatile Driving Controls**

- Built-in safe stop function
- Built-in brake unit
- Supports various network protocols
- Synchronous point-to-point control

▶ **Modular Design**

- Hot plug LCD keypad
- I/O extension cards
- Various PG (encoder) feedback cards
- Network cards for fieldbus modules

▶ **Environmental Adaptability**

- 50°C operating temperature
- Built-in DC reactor
- Coated circuit boards
- Built-in EMC filter
- Global safety standards (CE/UL/cUL)

Modular Design

- ▶ Various accessories options, such as I/O extension cards, encoder feedback cards, communication cards, hot plug LCD keypad, removable terminals and removable fan.

The diagram illustrates the modular design of a Delta drive unit. A central image shows the internal components of the drive, with blue lines connecting various slots to their respective external card options. The components shown include:

- PG (Encoder) cards:** EMC-PG010, EMC-PG01U, EMC-PG01L, and EMC-PG01R.
- I/O cards:** EMC-D611A and EMC-D42A.
- 24V Power Shift card:** EMC-BPS01.
- Relay card:** EMC-R6AA.
- Communication cards:** CMC-PD01, CMC-DN01, CMC-MOD01, CMC-EIP01, and EMC-COP01.
- Removable fan:** Located at the bottom of the drive unit.
- Power indicator:** Located at the bottom of the drive unit.
- Removable terminals:** Located at the bottom of the drive unit.

***NOTE: "●" are optional accessories.**

■ Removable fan
To ensure personal safety, do not begin wiring before the indicator light is off.

■ Power indicator
To prevent personal injury, please do not perform wiring before power indicator is off.

■ Removable terminals
Convenient wiring and safety equipment.



High-performance Field Oriented Control

The FOC+PG mode of C2000 Series can output 150% of starting torque at extremely low speeds for precise and stable speed control

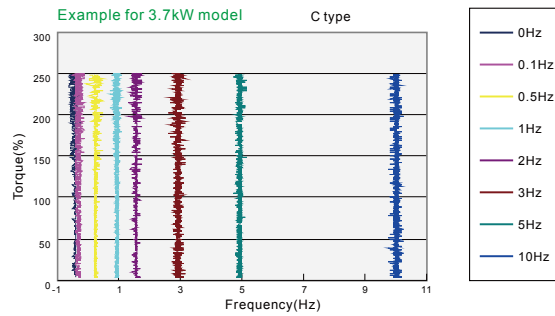

Auto Energy-Saving

During constant speed operation, this function auto-calculates the best voltage value by the load power for the load

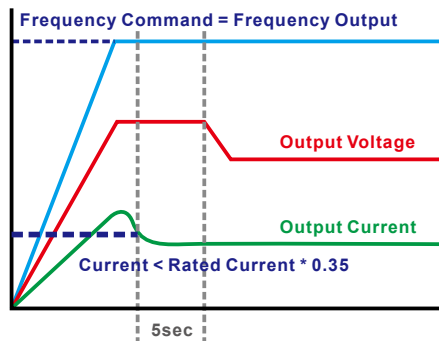

Built-in PLC Function

Built-in PLC programs. Distributed control and independent operation can be easily achieved via the network system.

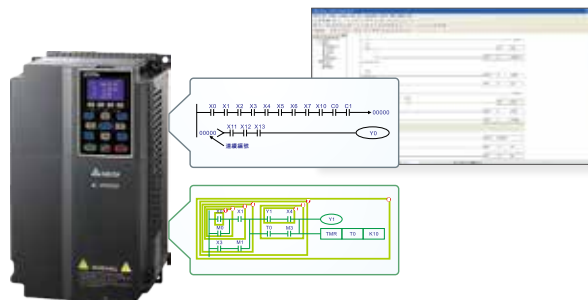

Deceleration Energy Backup (DEB)

This function controls the motor deceleration for stopping when an unexpected power shut down occurs to prevent mechanical damage. When power resumes, the motor will return to its previous speed.

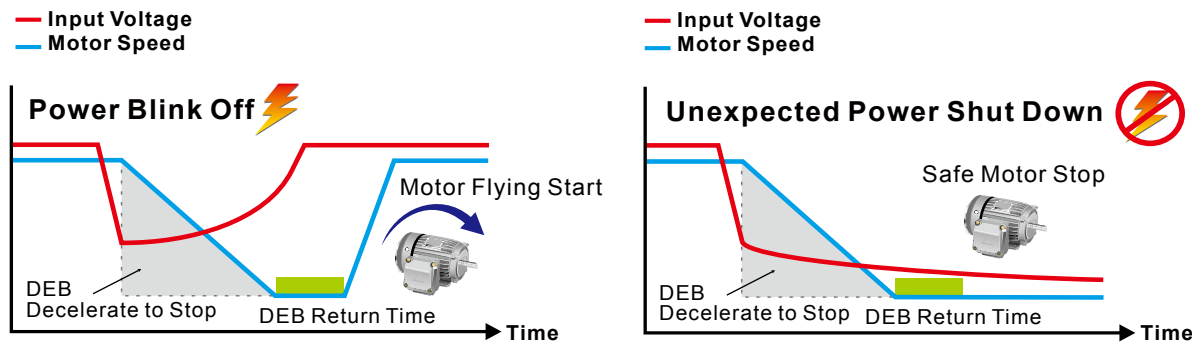

Standard Models (IP20/NEMA1)

- ▶ Power Range
 - 3-phase 230 V series: 0.75~90 kW (1 hp~125 hp)
 - 3-phase 460 V series: 0.75~450 kW (1 hp~600 hp)
 - 3-phase 575 V series: 1.5~15 kW (2 hp~20 hp)
 - 3-phase 690 V series: 18.5~630 kW (25 hp~745 hp)

Model Name

230 V / 460 V:

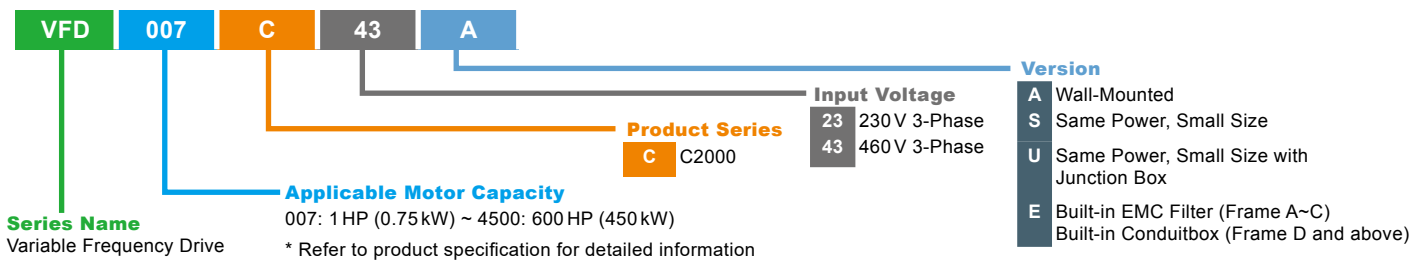

600 V / 690 V:

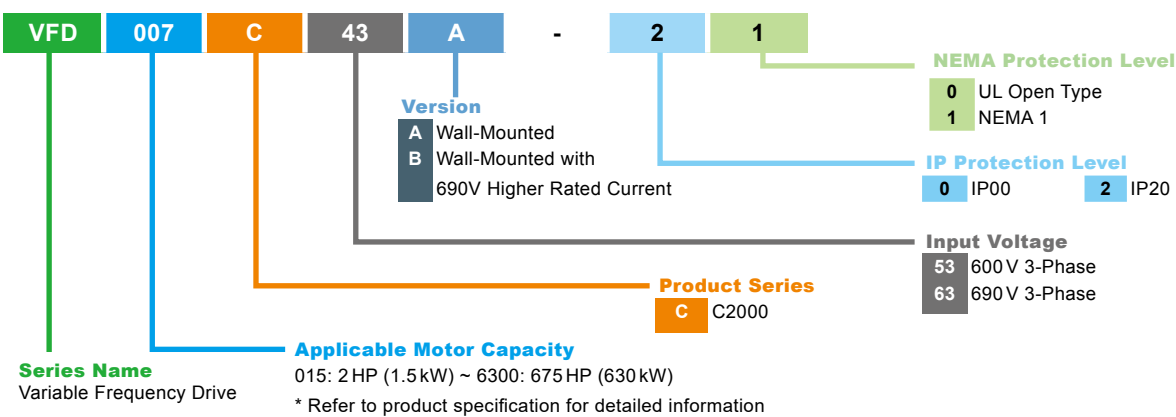

CP2000 Series

Features

- ▶ LCD keypad - An easy-to-use text panel with TP Editor software allows users to self-define the main page screen
- ▶ Quick setting functions to support self-defined parameter groups and parameter duplication for fast and easy installation
- ▶ Modular design for flexible extension and easy maintenance
- ▶ High-speed communications include BACnet and MODBUS. Optional communication cards are available upon purchase:



CANopen (DS402) **DeviceNet** **EtherNet/IP** **MODBUS TCP**

- ▶ Extended life cycle
- ▶ Enhanced conformal coating on PCBs for superior durability in critical environments
- ▶ Fire mode and bypass functions: continuous pressure to extract smoke when emergencies occur
- ▶ Various modes for fans/pumps applications including PID control, sleep/wake up functions, flying start and skip frequency
- ▶ Multi-pumps synchronous control of up to 8 motors at one time and provides fixed amount and fixed time circulation control
- ▶ Built-in 10K steps PLC programming capacity and Real Time Clock (RTC)

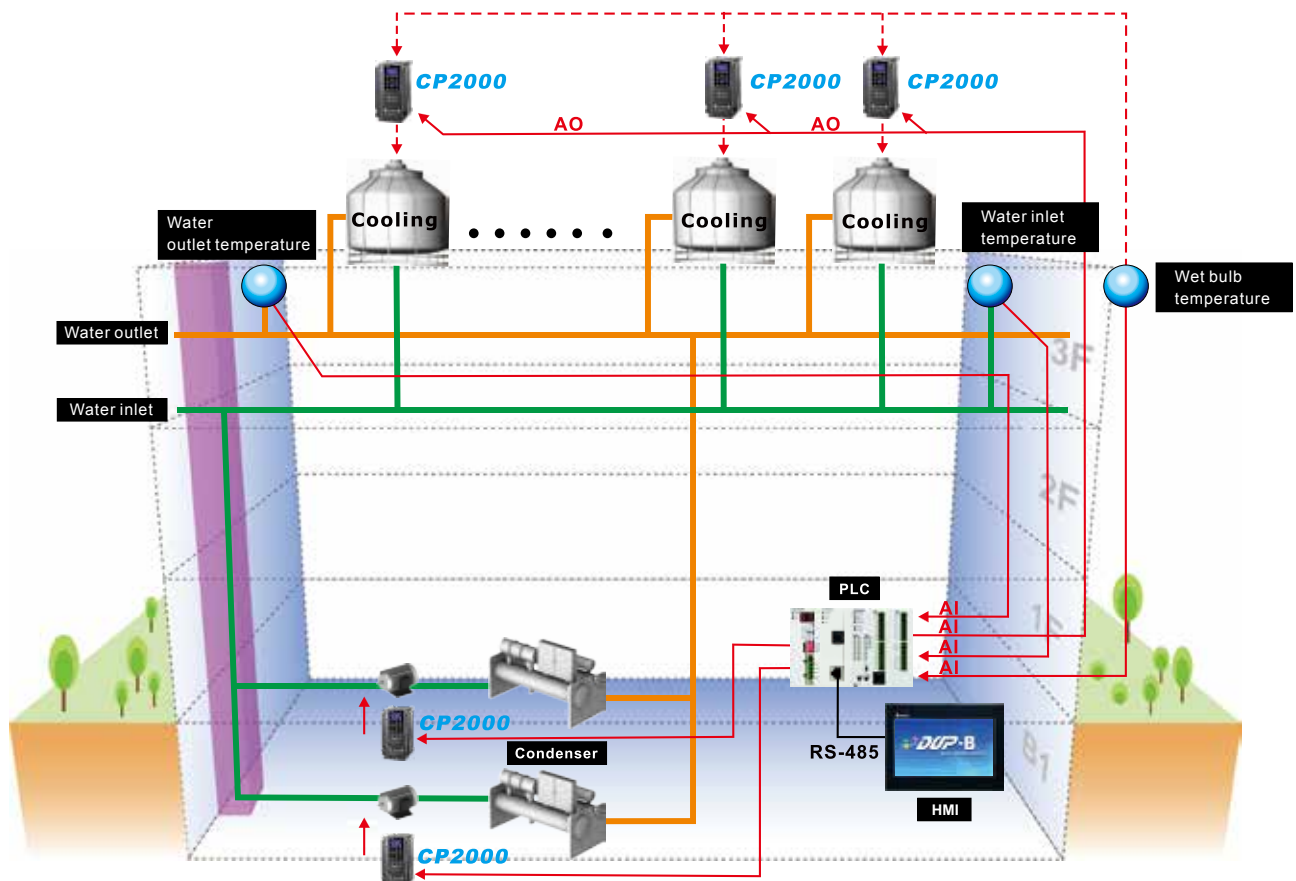

Improves Motor Performance

- ▶ Sensorless Vector Control (SVC) and auto-tuning functions to improve motor performance for variable torque load applications
- ▶ Deceleration Energy Backup (DEB) function decelerates motor to a stop when sudden power failure occurs to protect the equipment from damage
- ▶ Auto adjusting acceleration/deceleration speed, reduces mechanical vibration when activating and stopping the equipment and provides smooth operation
- ▶ Energy saving control functions include PID control, sleep/wakeup mode and auto-energy saving mode

Standard Models

- ▶ Power Range
 - 3-phase 230 V series: 0.75~90 kW (1 hp~125 hp)
 - 3-phase 460 V series: 0.75~500 kW (1 hp~675 hp)

Model Name

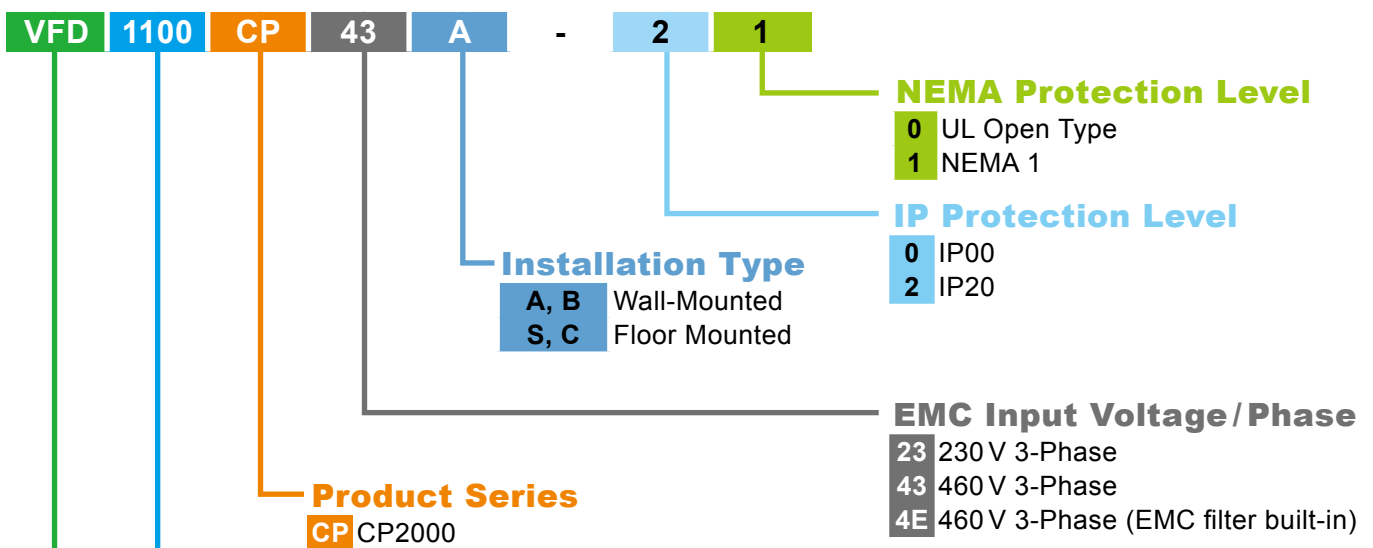

Applicable Motor Capacity

007	0.75 kW	075	7.5 kW	300	30 kW	900	90 kW	2200	220 kW
015	1.5 kW	110	11 kW	370	37 kW	1100	110 kW	2800	280 kW
022	2.2 kW	150	15 kW	450	45 kW	1320	132 kW	3150	315 kW
037	3.7 kW	185	18.5 kW	550	55 kW	1600	160 kW	3550	350 kW
055	5.5 kW	220	22 kW	750	75 kW	1850	180 kW	4000	400 kW
								5000	500 kW

Product

Variable Frequency Drive

CH2000 Series

Features

- ▶ Fast response to impact loads
- ▶ Super Heavy Duty (SHD) setting for high overload
- ▶ Large starting torque: above 200% at 0.5Hz, and 200% at 0Hz in FOC+PG mode
- ▶ Supports both asynchronous and synchronous motors
- ▶ Various crane functions for high operation performance
- ▶ Modular design facilitates installation process and is easy to maintain
- ▶ Built-in 10K steps PLC programming capacity
- ▶ Built-in MODBUS communication
- ▶ Optional communication cards:



CANopen

DeviceNet

EtherNet/IP

MODBUS TCP

Advanced Crane Function

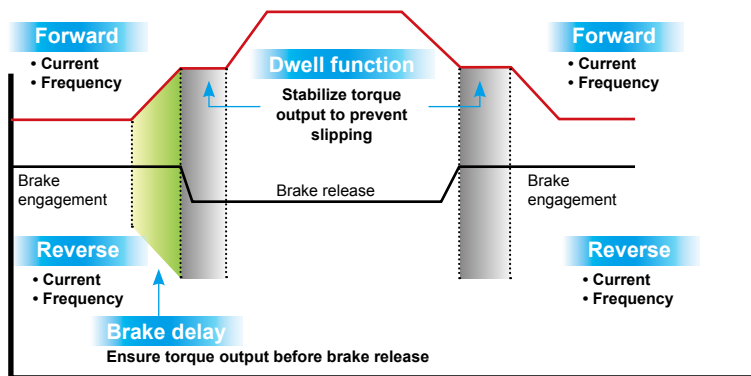

▲ Mechanical brake control

8 independent brake control setting to different criteria. High flexibility to meet complex application needs and ensure operation safety.

▲ Advanced crane time sequence

Brake delay and dwell function ensure smooth operation.

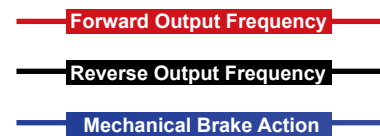

Auto-acceleration of Light Load

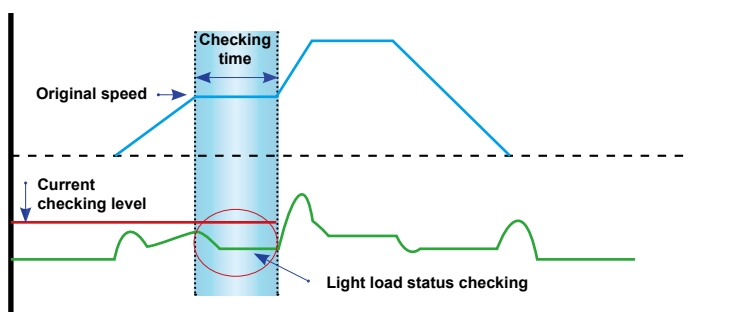

Excellent Overload Capability

The super heavy duty setting is suitable for harsh environment applications with a current overload capability of 150% for 60 seconds and 200% for 3 seconds.

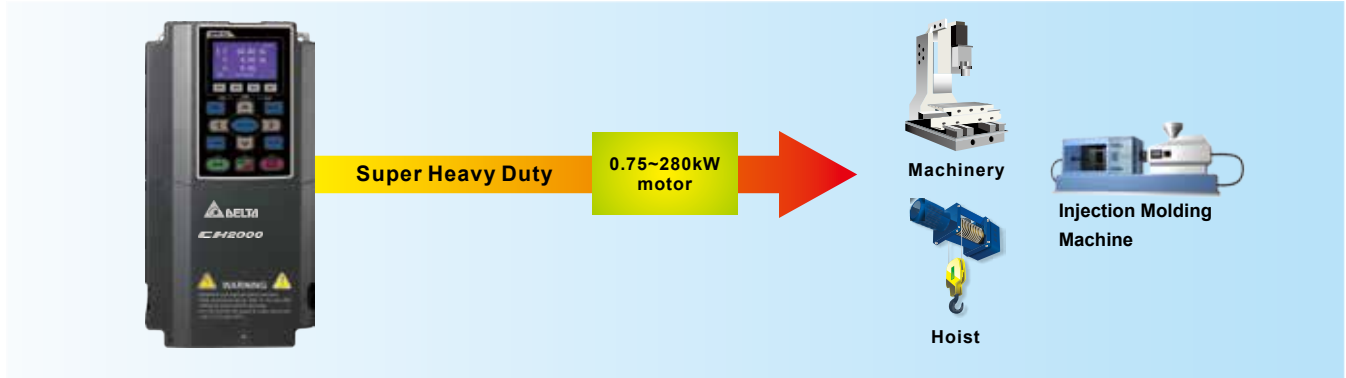

Standard Models

- ▶ Power Range
 - 3-phase 230V series: 0.75 ~ 75 kW (1 hp~100 hp)
 - 3-phase 460V series: 0.75 ~ 280 kW (1 hp~375 hp)

Model Name

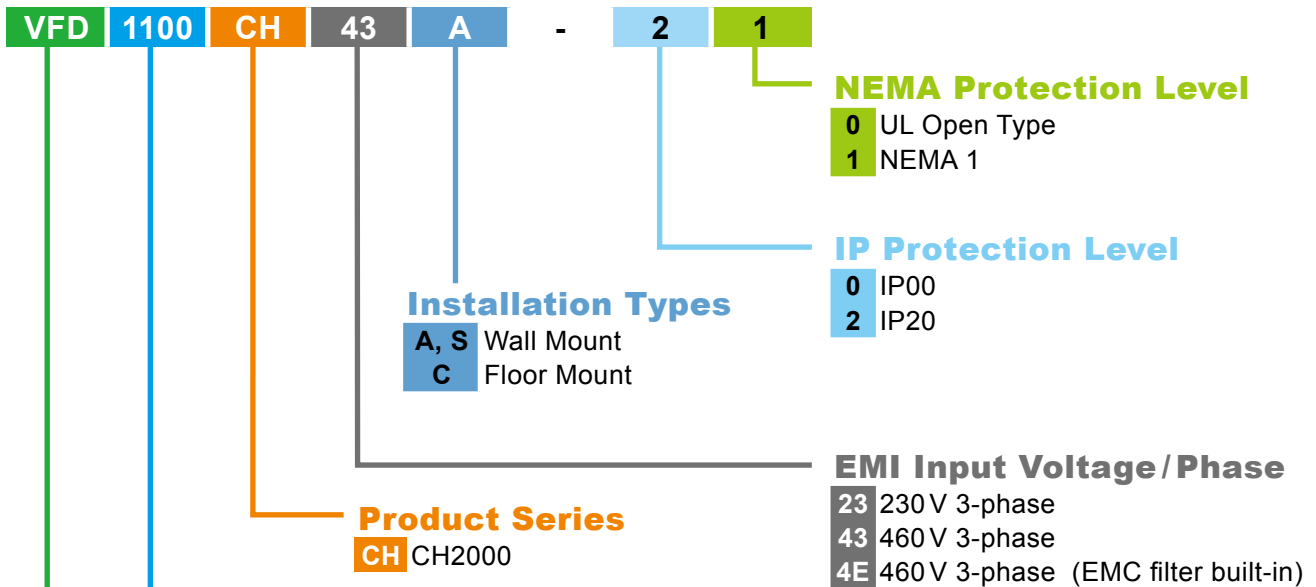

Applicable Motor Capacity

007	0.75 kW	075	7.5 kW	300	30 kW	900	90 kW	2200	220 kW
015	1.5 kW	110	11 kW	370	37 kW	1100	110 kW	2800	280 kW
022	2.2 kW	150	15 kW	450	45 kW	1320	132 kW		
037	3.7 kW	185	18.5 kW	550	55 kW	1600	160 kW		
055	5.5 kW	220	22 kW	750	75 kW	1850	180 kW		

Product
Variable Frequency Drive



C200

Series



Features

- ▶ Flexible and user-friendly interface supporting multi-point inputs, analog inputs, CANopen and RS-485 with MODBUS communication application flexibility
- ▶ Simple and fast installation, parameter setting and tuning
- ▶ Built-in 5K steps PLC programming capability
- ▶ Supports wall mount installation (Frame A)
- ▶ Enhanced conformal coating on PCB and thermal design suitable for harsh environment applications
- ▶ Instant response to sudden load impact and prevents inrush current from interrupting system operation

Built-in High-speed Fieldbus

- ▶ Built-in RS-485 with MODBUS communication
- ▶ CANopen (DS402)
 - Delta provides CANopen Builder software to facilitate the planning process
 - I/O data configuration for all products that support CANopen communication protocol



MKCB-HUB01

Built-in PLC Functions

- ▶ Built-in PLC programs. Distributed control and independent operation can be easily achieved via the network system.

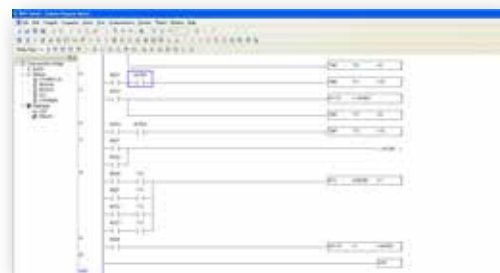

Permanent Magnet Synchronous Motor

- ▶ The C200 Series provides a PM Sensorless control function for open-loop speed control. It is suitable for compressors and vacuum pumps.

Field Applications

Easy to use with high safety standard and versatile control functions for applications that require speed.

- ▶ Processing machines
- ▶ Packaging machines
- ▶ Textile machines
- ▶ Printing machines
- ▶ Material handling machines
- ▶ Treadmills
- ▶ Solar equipment
- ▶ Fans, pumps

Standard Models

- ▶ Power Range
 - 1-phase 230V series: 0.4~2.2 kW (0.5hp~3hp)
 - 3-phase 230V series: 0.4~3.7 kW (0.5hp~5hp)
 - 3-phase 460V series: 0.75~7.5 kW (1hp~10hp)

Model Name

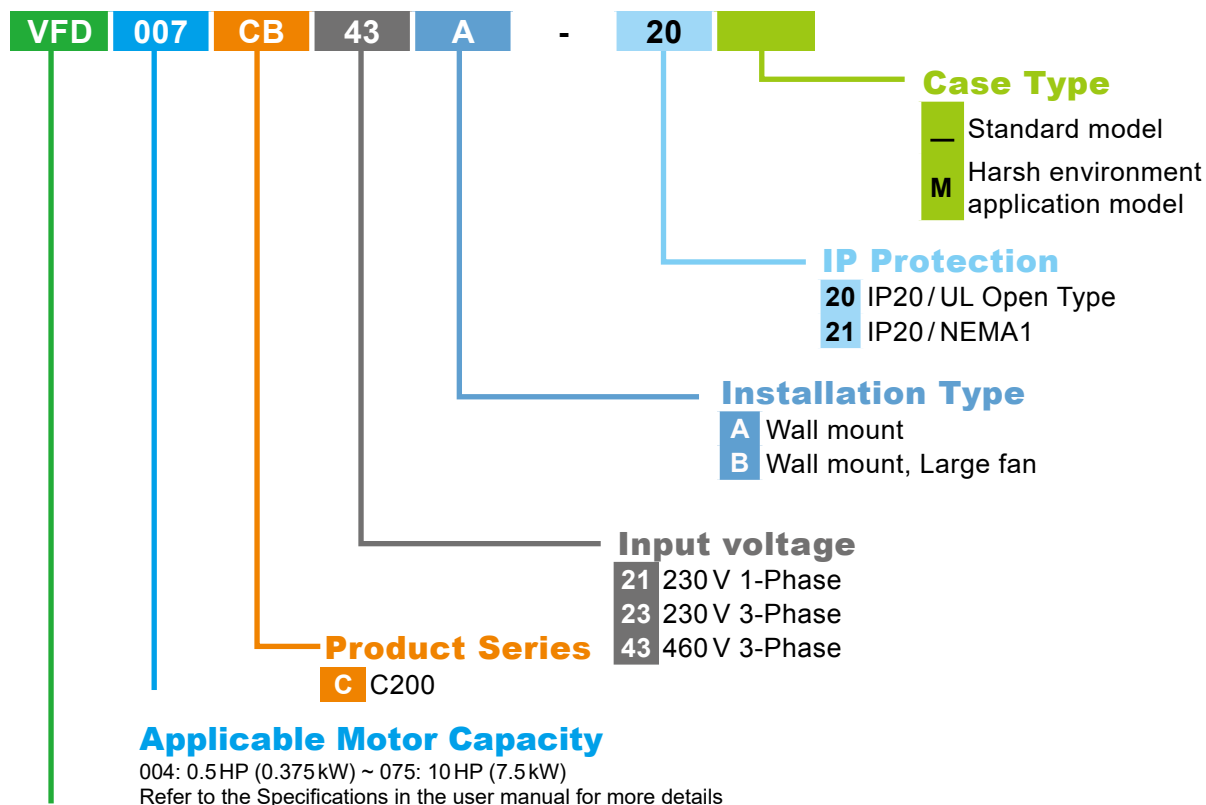

Product

Variable Frequency Drive

VFD-E/EL Series

Features

▶ Compact Design

Space saving and easy DIN rail mounting with optional DIN rail adapter (Built in Frame B)

▶ Built-in EMC Filter (230V 1-phase and 460V 3-phase)

Reduces electromagnetic interference efficiently

▶ Flexible Extension (VFD-E Series Only)

Via optional cards, such as I/O card, Relay card, PG (Encoder) card and USB card, to meet your application requirements



▶ RFI Switch for IT Mains

Removable "Y" capacitor to use with IT mains supplies



▶ Standard MODBUS Protocol

Standard MODBUS Protocol via RS-485

▶ Built-in PLC Function (VFD-E Series Only)

PLC programming and editing capability without the need of a PLC

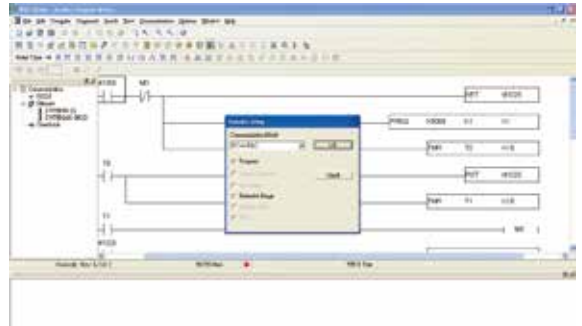

▶ Side-by-side Installation (40°C)

High-efficiency cooling and flexible spacing



Accessories

▶ Fieldbus Modules



- Profibus
- DeviceNet
- CANopen

▶ Others



- Digital keypad
- Keypad for communication (VFD-PU06)
- Grounding plate



- Brake resistor
- Brake unit
- DIN rail (Width 35mm)

Accessories

▶ Optional Cards (VFD-E Series Only)



■ **EME-PG01**
PG card

- **EME-R3AA**
Relay card (3 form A / NO contacts)
- **EME-R2CA**
Relay card (2 form C / Change-over contacts)
- **EME-33A**
I/O card (photocoupler 3in + 3out)

- **EME-A22A**
Analog I/O Card (12 bits)
- **CME-USB01**
Second communication card (USB1.1)

External Parts

▶ VFD-E Series

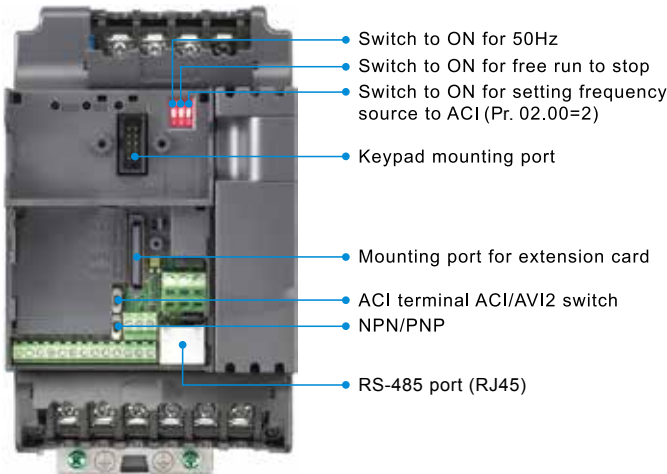

▶ VFD-EL Series

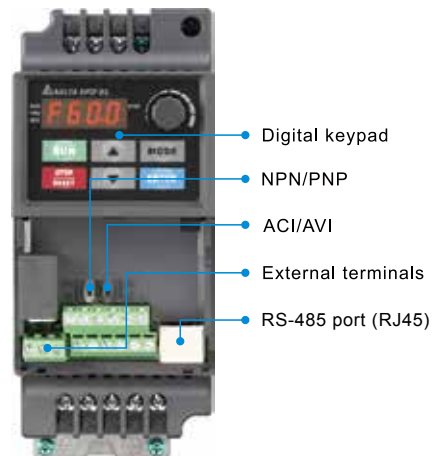

Standard Models

▶ Power Range

VFD-E Series:

- 1-phase 115V series: 0.2~0.75kW (0.25~1 hp)
- 1-phase 230V series: 0.2~2.2kW (0.25~3 hp)
- 3-phase 230V series: 0.2~7.5kW (0.25~20 hp)
- 3-phase 460V series: 0.4~22 kW (0.50~30 hp)

VFD-EL Series:

- 1-phase 115V series: 0.2~0.75kW (0.25~1 hp)
- 1-phase 230V series: 0.2~2.2kW (0.25~3 hp)
- 3-phase 230V series: 0.2~3.7kW (0.25~5 hp)
- 3-phase 460V series: 0.4~3.7kW (0.50~5 hp)

Model Name

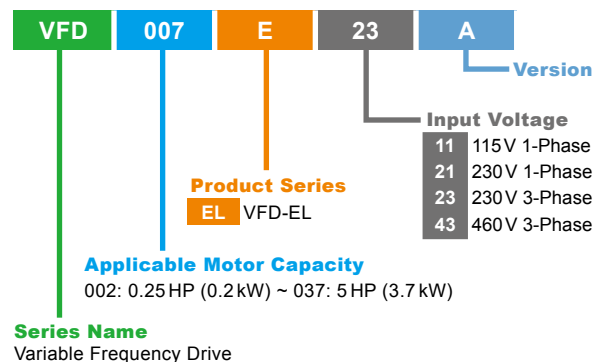
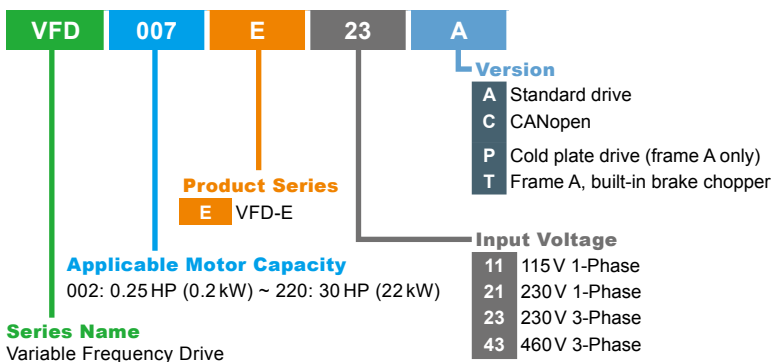



Smarter. Greener. Together.

Industrial Automation Headquarters

Delta Electronics, Inc.

Taoyuan Technology Center
No.18, Xinglong Rd., Taoyuan District,
Taoyuan City 33068, Taiwan
TEL: 886-3-362-6301 / FAX: 886-3-371-6301

Asia

Delta Electronics (Shanghai) Co., Ltd.

No.182 Minyu Rd., Pudong Shanghai, P.R.C.
Post code : 201209
TEL: 86-21-6872-3988 / FAX: 86-21-6872-3996
Customer Service: 400-820-9595

Delta Electronics (Japan), Inc.

Tokyo Office
Industrial Automation Sales Department
2-1-14 Shibadaimon, Minato-ku
Tokyo, Japan 105-0012
TEL: 81-3-5733-1155 / FAX: 81-3-5733-1255

Delta Electronics (Korea), Inc.

Seoul Office
1511, 219, Gasan Digital 1-Ro., Geumcheon-gu,
Seoul, 08501 South Korea
TEL: 82-2-515-5305 / FAX: 82-2-515-5302

Delta Energy Systems (Singapore) Pte Ltd.

4 Kaki Bukit Avenue 1, #05-04, Singapore 417939
TEL: 65-6747-5155 / FAX: 65-6744-9228

Delta Electronics (India) Pvt. Ltd.

Plot No.43, Sector 35, HSIIDC Gurgaon,
PIN 122001, Haryana, India
TEL: 91-124-4874900 / FAX : 91-124-4874945

Delta Electronics (Thailand) PCL.

909 Soi 9, Moo 4, Bangpoo Industrial Estate (E.P.Z),
Pattana 1 Rd., T.Phraksa, A.Muang,
Samutprakarn 10280, Thailand
TEL: 66-2709-2800 / FAX : 662-709-2827

Delta Energy Systems (Australia) Pty Ltd.

Unit 20-21/45 Normanby Rd., Notting Hill Vic 3168, Australia
TEL: 61-3-9543-3720

Americas

Delta Electronics (Americas) Ltd.

Raleigh Office
P.O. Box 12173, 5101 Davis Drive,
Research Triangle Park, NC 27709, U.S.A.
TEL: 1-919-767-3813 / FAX: 1-919-767-3969

Delta Greentech (Brasil) S/A

São Paulo Office
Rua Itapeva, 26 – 3° Andar - Bela Vista
CEP: 01332-000 – São Paulo – SP - Brasil
TEL: 55-11-3530-8642 / 55-11-3530-8640

Delta Electronics International Mexico S.A. de C.V.

Mexico Office
Vía Dr. Gustavo Baz No. 2160, Colonia La Loma,
54060 Tlalnepantla Estado de Mexico
TEL: 52-55-2628-3015 #3050/3052

EMEA

Delta Electronics (Netherlands) BV

Eindhoven Office
De Witbogt 20, 5652 AG Eindhoven, The Netherlands
MAIL: Sales.IA.EMEA@deltaww.com
MAIL: Sales.IA.Benelux@deltaww.com

Delta Electronics (France) S.A.

ZI du bois Chaland 2 15 rue des Pyrénées,
Lisses 91056 Evry Cedex, France
MAIL: Sales.IA.FR@deltaww.com

Delta Electronics Solutions (Spain) S.L.U

Ctra. De Villaverde a Vallecas, 265 1° Dcha Ed.
Hormigueras – P.I. de Vallecas 28031 Madrid
C/Llull, 321-329 (Edificio CINC) | 22@Barcelona, 08019 Barcelona
MAIL: Sales.IA.Iberia@deltaww.com

Delta Electronics (Italy) Srl

Ufficio di Milano Via Senigallia 18/2 20161 Milano (MI)
Piazza Grazioli 18 00186 Roma, Italy
MAIL: Sales.IA.Italy@deltaww.com

Delta Electronics (Germany) GmbH

Coesterweg 45, D-59494 Soest, Germany
MAIL: Sales.IA.DACH@deltaww.com

Delta Energy Systems LLC (CIS)

Vereyskaya Plaza II, office 112 Vereyskaya str.
17 121357 Moscow, Russia
MAIL: Sales.IA.RU@deltaww.com

Delta Greentech Ltd. (Turkiye)

Serifali Mevkii Barbaros Bulvari Soylesi Sok
No 19 34775, Y.Dudullu-Umraniye/Istanbul
MAIL: Sales.IA.Turkey@delta-emea.com

Delta Energy Systems AG (Dubai BR)

P.O. Box 185668, Gate 7, 3rd Floor, Hamarain Centre,
Dubai, United Arab Emirates
MAIL: Sales.IA.MEA@deltaww.com

COMTECH

Via Polesine, 1/4
10020 Cambiano (TO) Italy
+39 011 9454523
www.e-comtech.it

info@e-comtech.it